PM200-01D (dual)

Advertising System

Installation Guide



Contents

About this Guide.....	1
About the Product.....	1
Installation Requirements.....	2
Installation.....	6

About this Guide

This installation guide explains how to install the PM200-01D, which contains a transmitter pedestal and a receiver pedestal as one set. Other related documents are:

- RX tuning guide
- TX tuning guide

About this Product

The PM200-01D deters theft by activating alarm when it detects the unique response of an active reusable tag or disposable tag.

Pedestal Configuration

One transmitter and one receiver or multiple transmitter and multiple receiver pedestals can be configured to cover different exit widths and to adapt to different architectural requirements.

- Single system
One transmitter and one receiver pedestals provides up to 1.8m (6') of coverage.
- Multiple transmitters system
Two or not more than seven transmitters are used in one installation, providing more exit coverage.

Note:

The synchronization setup needs to be configured between transmitters in a multiple transmitter system installation. [Please refer to TX tuning guide for details]

Component Product Code

PM200-01D transmitter pedestal	PM200-01D TX
PM200-01D receiver pedestal	PM200-01D RX
System power supply	PM-24DC

Installation Requirements

Pedestal Placement/Cabling



WARNING: DO NOT run the power and interconnect cable in the same conduit or raceway. Building codes require that power wiring be separated from other types of wiring.

☞ The ac source must be a 3 wire, 24- hour non-switched outlet with less than 0.5Vac between neutral and ground.

☞ DO NOT share the ac source with neon signs, motors, computers, cash registers, terminals, or data communications equipment.

☞ Whenever possible, keep the pedestals at least 2.4m (8') away from noise sources such as elevators, automatic door, computer monitors, TV's, switching power supplies and neon displays.

☞ Maximum distance between the transmitter and receiver pedestals is 1.8m (6') measured from the pedestal center to pedestal center. Minimum distance between two pedestals is 0.6m (2') measured from the pedestal center to pedestal center.

Tools and Equipment Required

- ③ Plastic or kinds of sheeting (to protect nearby items from dust)
- ③ Floor saw
- ③ Power drill with 15mm (0.6") diameter drill bit
- ③ Phillips and slotted screwdrivers
- ③ 14mm (0.55") diameter bolts and nuts
- ③ Hand vacuum and broom

Side View

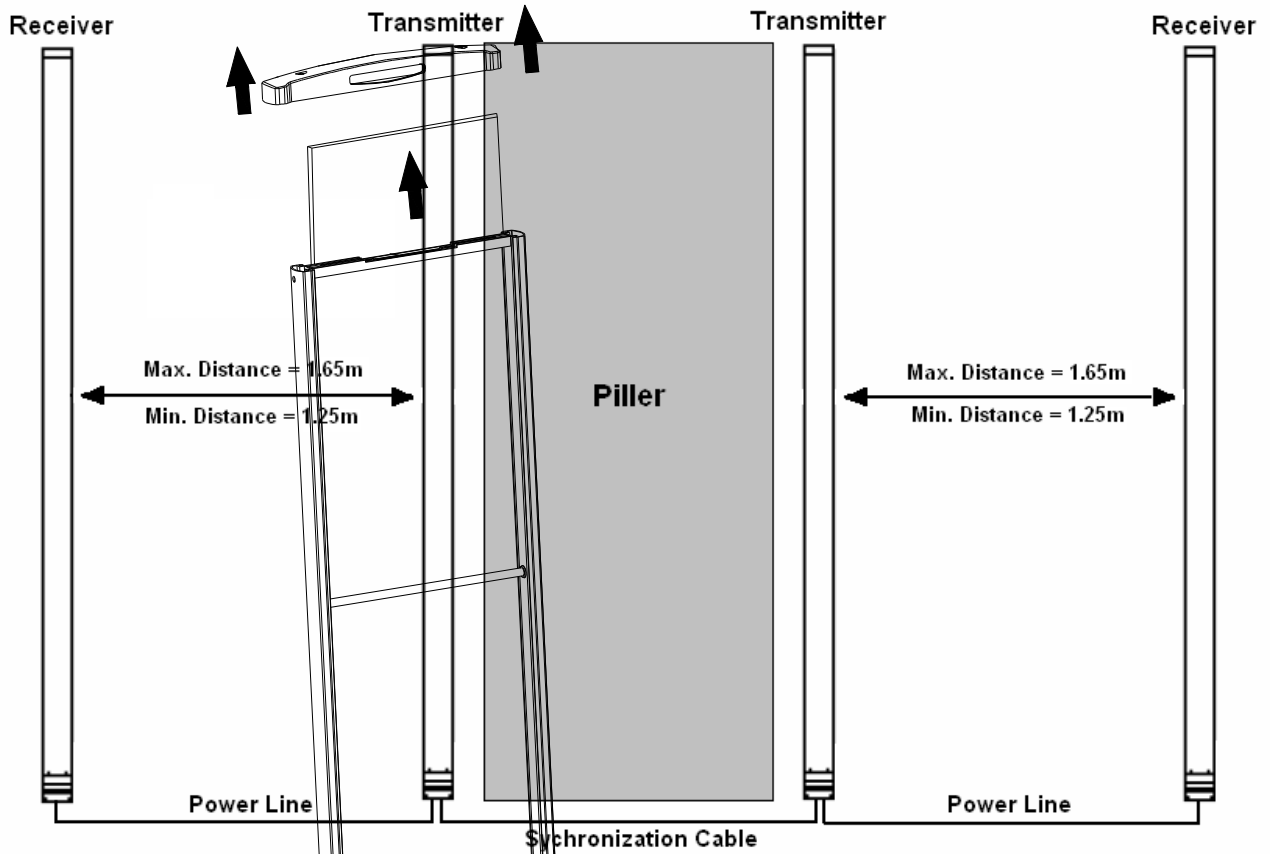
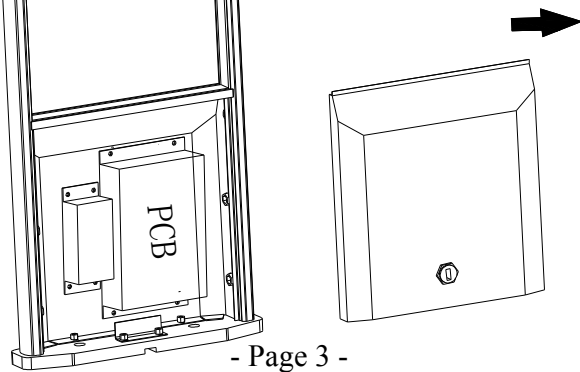
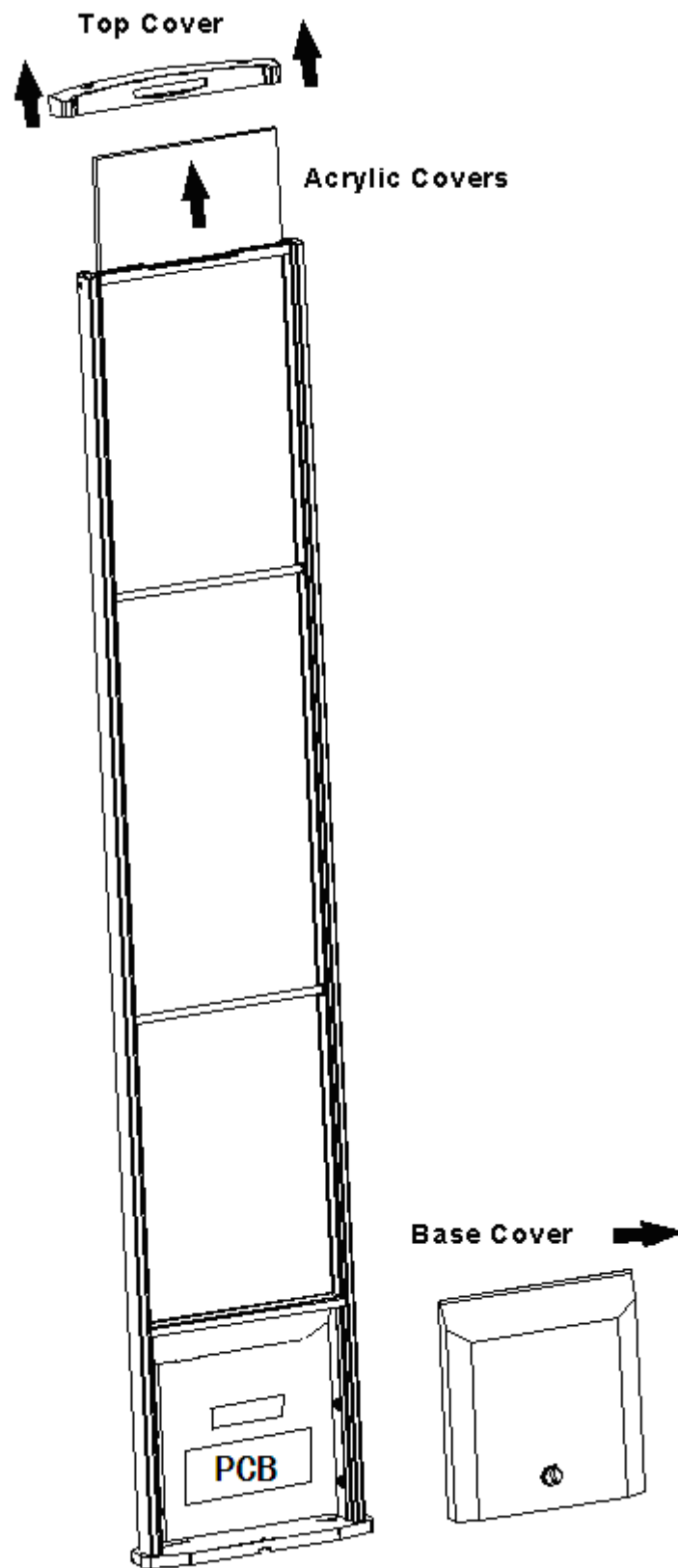

Figure 2 PM200-01D installation





**Figure 3 PM200-01D Pedestal
Dismantling**

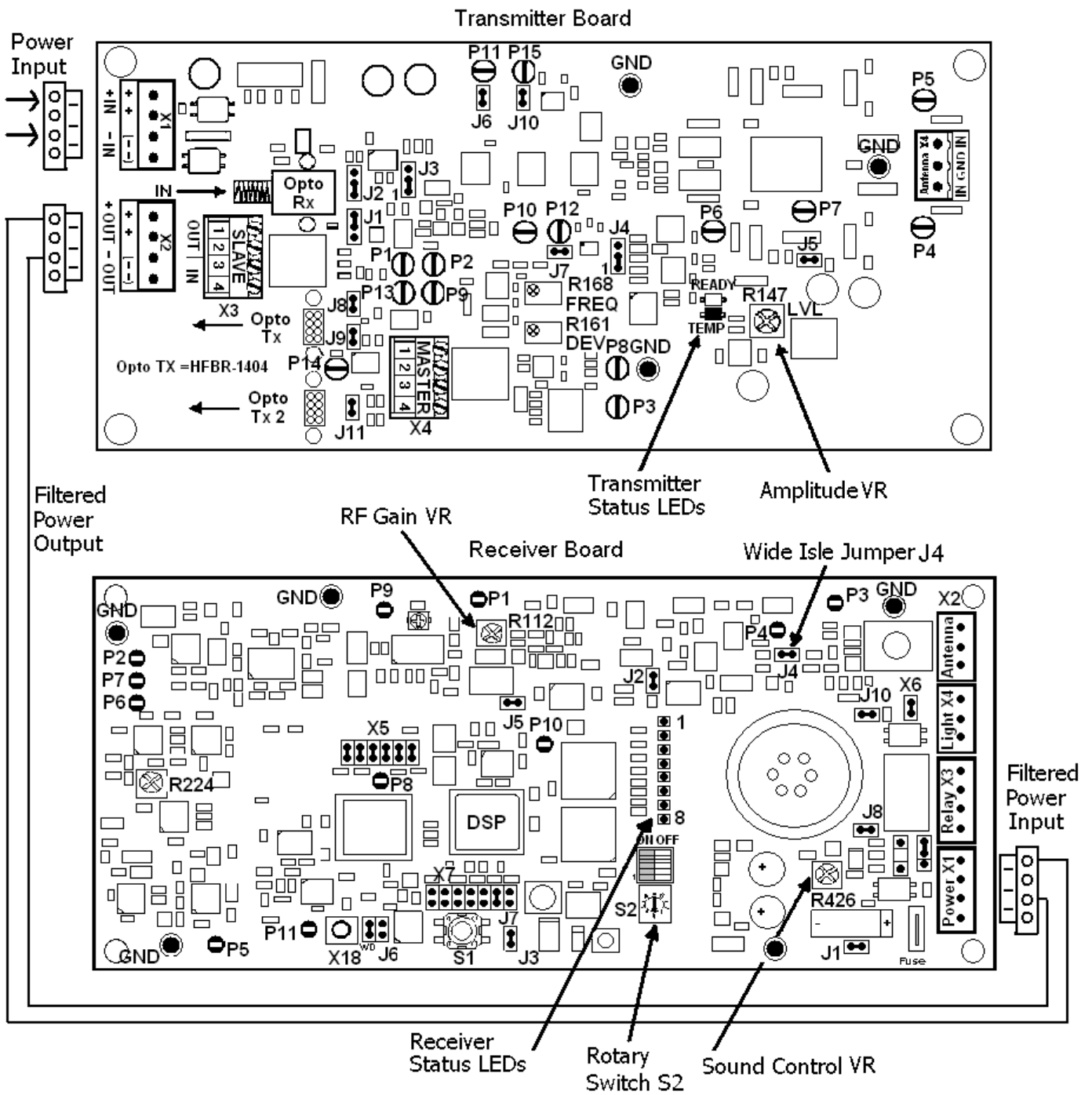

Figure 4 Boards Configuration

Installation

The following instructions refer to Figure 4 and 5.

The pedestal is floor-mounted using four bolts and anchors. Cable openings in the base allow the cable entry under beneath the pedestal. [Refer to Figure 3]

Dismantling

1. Remove Top Cover and Acrylic Panels. *Please take note that after you unscrew Top Cover, we have to remove the crocodile clips hold onto the buzzer too*

2. Unscrew the base covers *Please take note that there is no need to remove acrylic panels and top cover for PM200-01D. The acrylic panels are firmly fixed, so they will not drop, even if the base covers are removed.*

3. Connect power input connector to transmitter board
4. Connect filtered power connectors up between transmitter board to receiver board.
5. Power up the units, immediately the beep sound will come from the receiver pedestal

Check the transmitter board

6. Check double green and red transmitter Status LEDs are lit or not. If not, please refer to the TX tuning guide for troubleshooting.

Check the receiver board

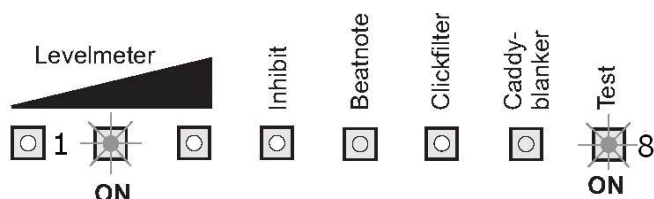

7. Check the receiver status LEDs, see if

Test LED (the eighth) is blinking or not. If not, please refer to the RX tuning guide for troubleshooting.

8. Set Rotary Switch S2 to position 0.

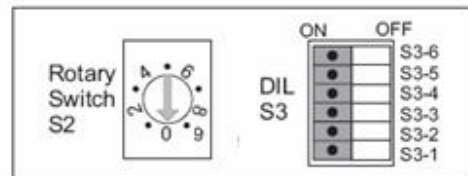

9. Turn the RF-Gain VR until only the Center LED of the Levelmeter is ON

Levelmeter	Action
	Turn from fully counter clockwise until a yellow LED goes on.
	Turn clockwise to find the yellow Center LED.
	Turn slowly clockwise until only the yellow Center LED is on.
	OK, Perfect
	Turn slowly counter clockwise until the yellow Center LED is on.
	Turn counter clockwise to find the yellow Center LED.

10. If the LED of the Levelmeter cannot be adjusted to Center and it always lies on left side, this means RF Gain is not enough. We can either open Wide Isle Jumper J4 or turn Amplitude VR on transmitter board clockwise to increase transmitter power.

11. If the LED of the Levelmeter always lies on right side or the Inhibit LED is lit, this means RF Gain is too high. We can either close Wide Isle Jumper J4 or turn Amplitude VR on transmitter board counter-clockwise to decrease transmitter power.

12. After confirm only the Center LED of the Levelmeter is ON, set Rotary Switch S2 to position 9 – Running Mode.

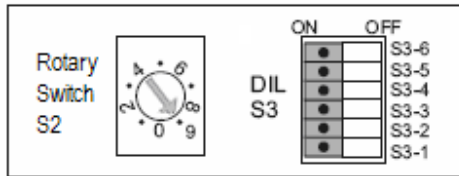

13. Adjust the Sound Control VR to control the sound level to acceptable volume.

Please ensure that crocodile clips (red clip to +ve pole; blue clip to -ve pole) are clipped onto the buzzer for test out

Assembling

14. Assemble Base Covers, Acrylic Covers and Top Cover back.